

RUS ȚIGLĂ CU VERSANT STANDARD LATERAL STANGA

Cea mai larga gama de aplicatii permite solutii individuale de acoperis. Ideal pentru renovare si constructii noi. Forma elegant si discreta pentru zonele de acoperis de o frumusetate clasica. Gama larga de culori.

DATE TEHNICE

Mărime (aprox.)	180 x 380 x 14 mm
Lățime de acoperire max. (aprox)	180 mm
Dist. min. șipci (aprox.)	145 mm
Lungime acoperire medie aprox.	155 mm
Dist. max. șipci (aprox.)	165 mm
Necesar min. de țigle (aprox.)	33.6 buc/m ²
Necesar mediu de țigle (aprox.)	36 buc/m ²
Greutate/unitate de produs - buc. (aprox.)	1.8 Kg/buc
greutate per m ² (aprox.)	64.8 kg/m ²
greutate per pallet (aprox.)	927 Kg
Buc. per mini-pack	8 bucati
Buc per palet	480 bucati



DSC/ISC VALORI

DSC/ISC VALORI IN MM PENTRU SIPCA 30X50.										
Necesar țiglă de coamă (aprox.)	DN	20°	25°	30°	35°	40°	45°	50°	55°	60°
BG 3.0 buc/m	LAF	90	85	80	80	80	75	75	80	85
BMK 3.0 buc/m	LAF			60	60	55	55	50	50	45
BMZ 2.7 buc/m	LAF	90	85	80	75	75	75	75	80	80
BM 3.0 buc/m	LAF	90	85	80	80	80	75	75	85	85
BZ 3.0 buc/m	LAF	90	85	80	75	75	75	75	80	

DSC/ISC VALORI IN MM PENTRU SIPCA 40X60.										
Necesar țiglă de coamă (aprox.)	DN	20°	25°	30°	35°	40°	45°	50°	55°	60°
BG 3.0 buc/m	LAF	85	80	75	75	75	65	60	65	70
BMK 3.0 buc/m	LAF			55	55	50	45	35		
BMZ 2.7 buc/m	LAF	85	80	75	70	70	65	60	65	65
BM 3.0 buc/m	LAF	85	80	75	75	75	65	60	70	70
BZ 3.0 buc/m	LAF	85	80	75	70	70	65	60	65	

DSC/ISC VALORI IN MM PENTRU SIPCA 50X50.										
Necesar țiglă de coamă (aprox.)	DN	20°	25°	30°	35°	40°	45°	50°	55°	60°
BG 3.0 buc/m	LAF	80	75	70	65	65	55	50	55	55
BMK 3.0 buc/m	LAF			50	45	40	35	25		
BMZ 2.7 buc/m	LAF	80	75	70	60	60	55	50	55	50
BM 3.0 buc/m	LAF	80	75	70	65	65	55	50	60	55
BZ 3.0 buc/m	LAF	80	75	70	60	60	55	50	55	



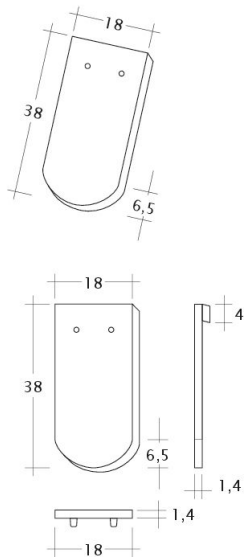

Desen tehnic produs KLASSIK 1-1

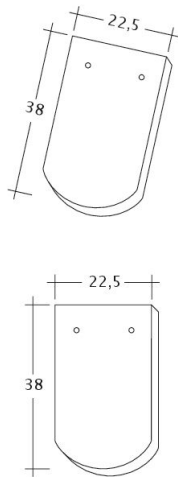

Desen tehnic produs KLASSIK 1-1-4



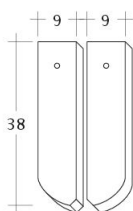
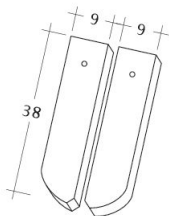

Desen tehnic produs KLASSIK 1-2

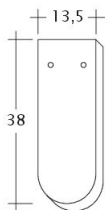
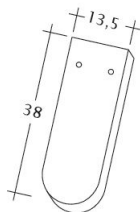

Desen tehnic produs KLASSIK 3-4



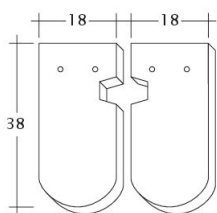
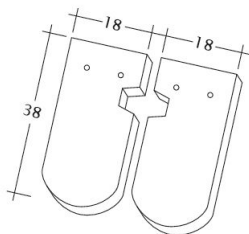

Desen tehnic produs KLASSIK Ausschnitt-LUEFTZ

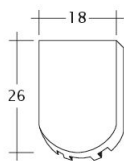
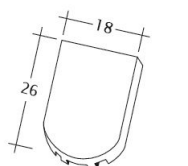

Desen tehnic produs KLASSIK FALZ



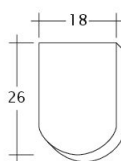
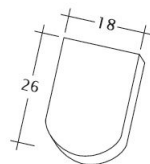

Desen tehnic produs KLASSIK Firstanschluss

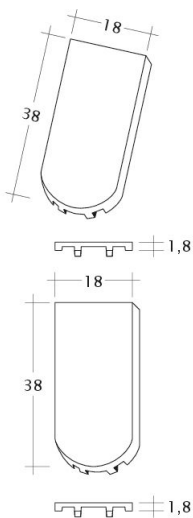

Desen tehnic produs KLASSIK Flaechenluefter



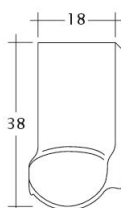
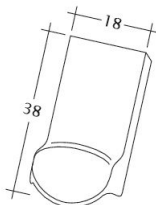

Desen tehnic produs KLASSIK LUEFTZ

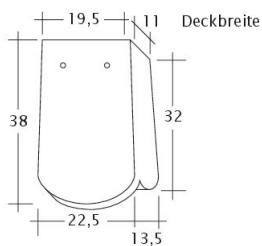
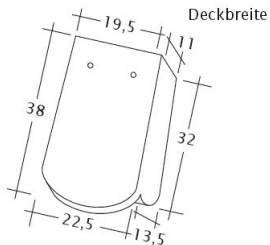

Desen tehnic produs KLASSIK OG-1-1-4



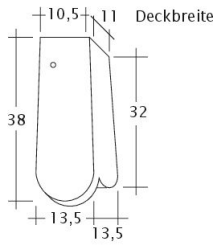
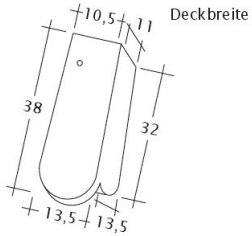

Desen tehnic produs KLASSIK OG-3-4

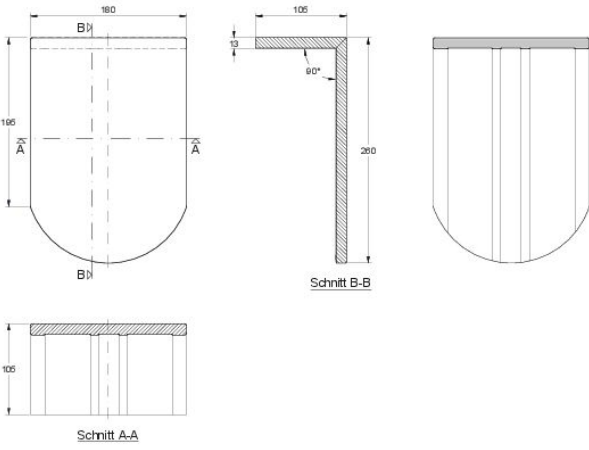

Desen tehnic produs KLASSIK PULT-kurz



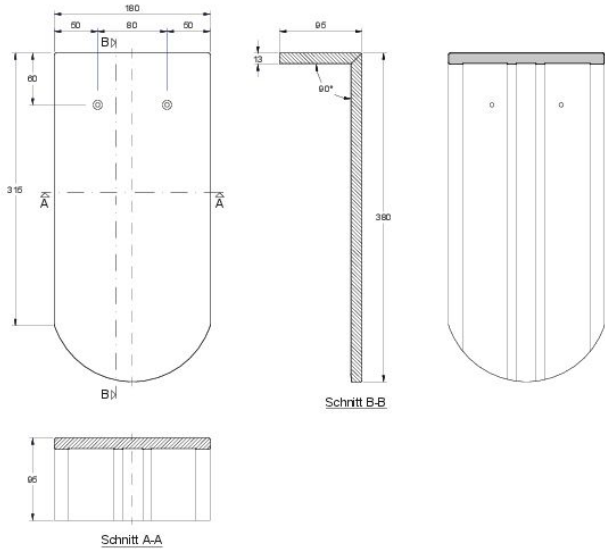

Desen tehnic produs KLASSIK PULT-lang

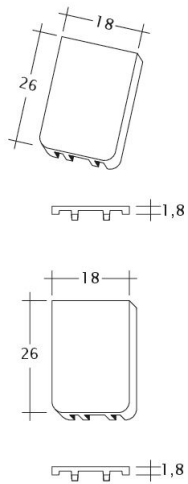

Desen tehnic produs KLASSIK Traufleuefter



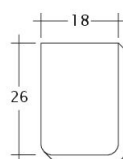
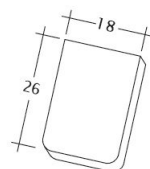

Desen tehnic produs KLASSIK Traufziegel

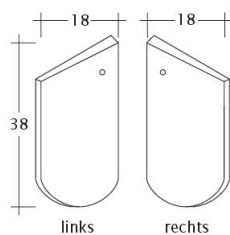
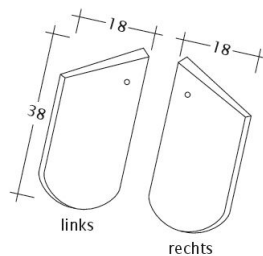

Desen tehnic produs KLASSIK Unterlaeuffer



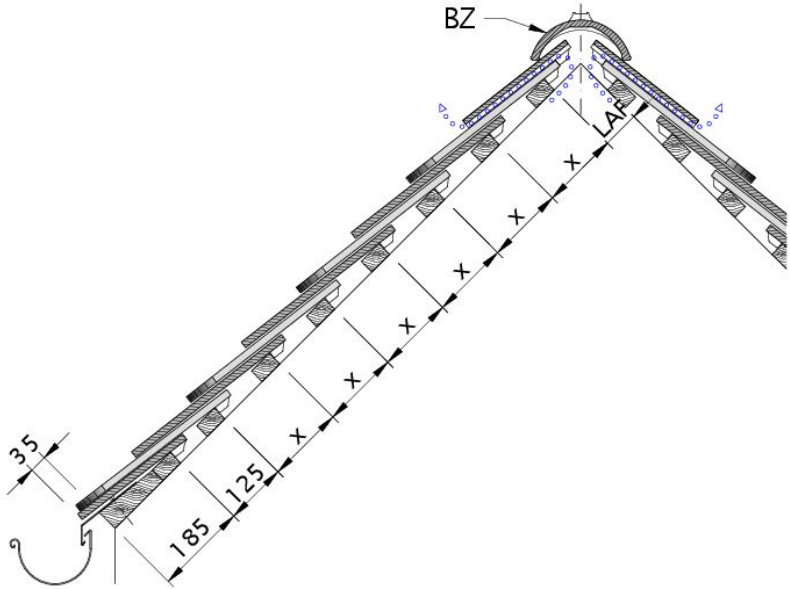

Desen tehnic produs KLASSIK DQF DQD-1

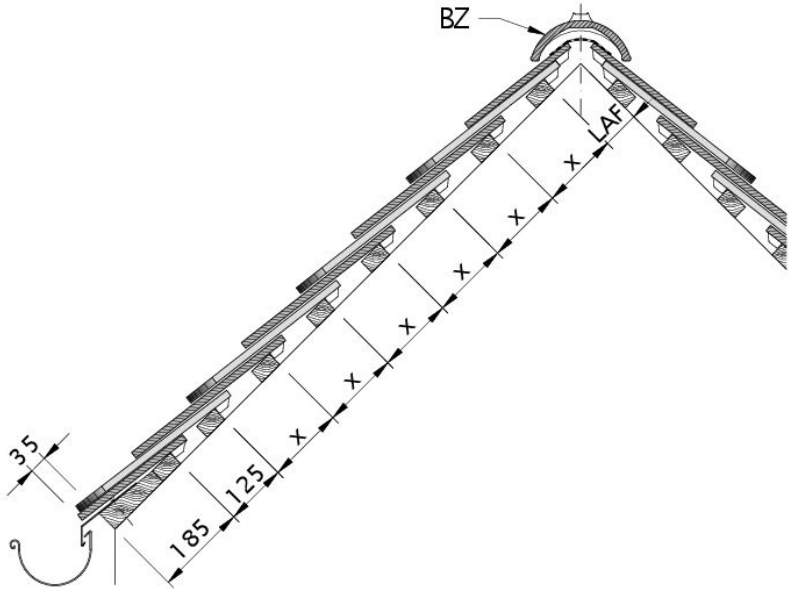

Desen tehnic produs KLASSIK DQF DQD-2



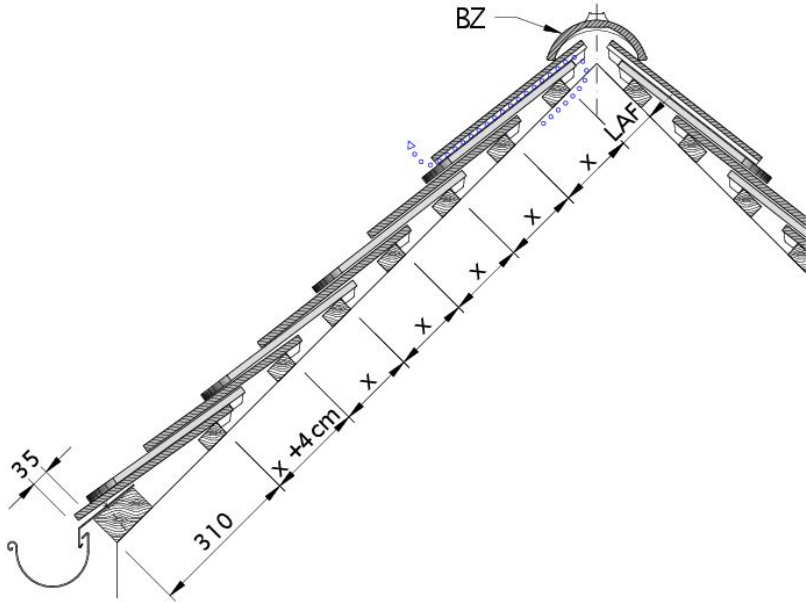

Desen tehnic produs KLASSIK DQF DQD-3

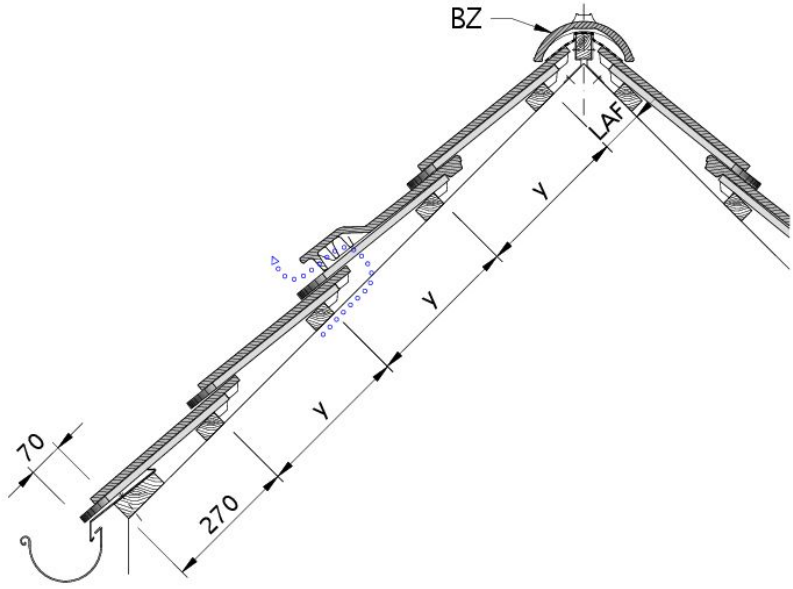

Desen tehnic produs KLASSIK DQF DQK-1



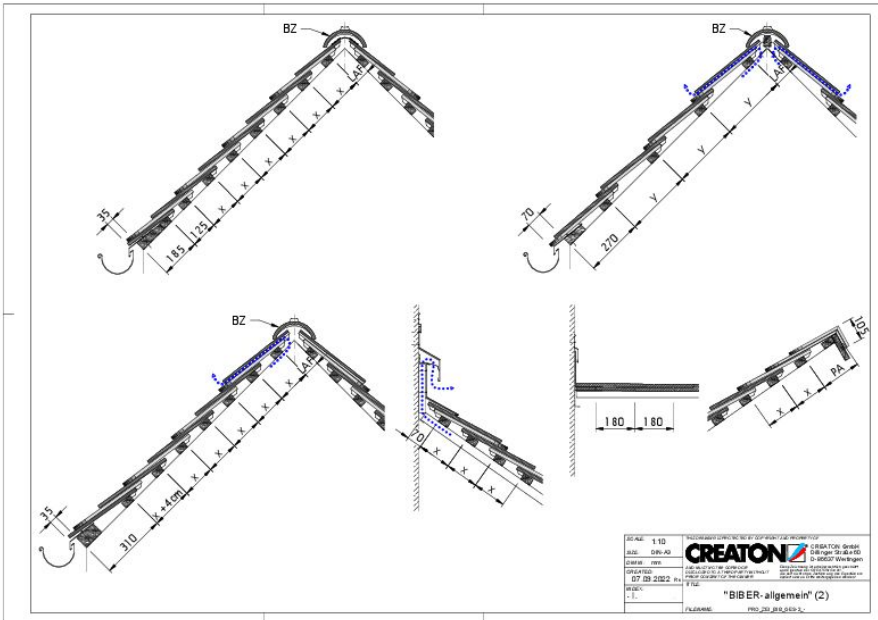

Drawing KLASSIK general view GES-2

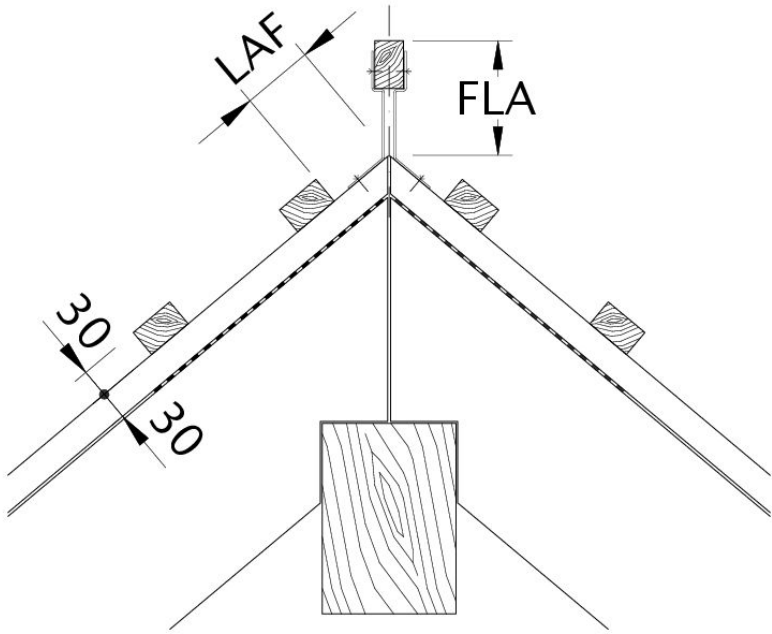

Desen tehnic produs KLASSIK DSC LAF



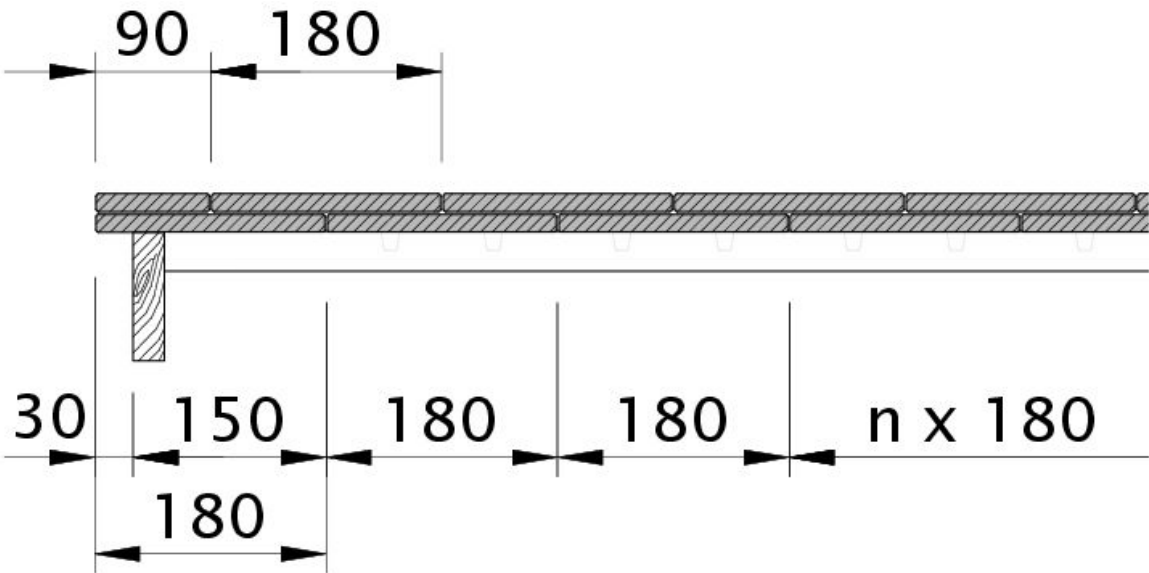

Zeichnung KLASSIK Ortgangziegel links mit Ortgangbrett und 1 1/2 Biber OBL112

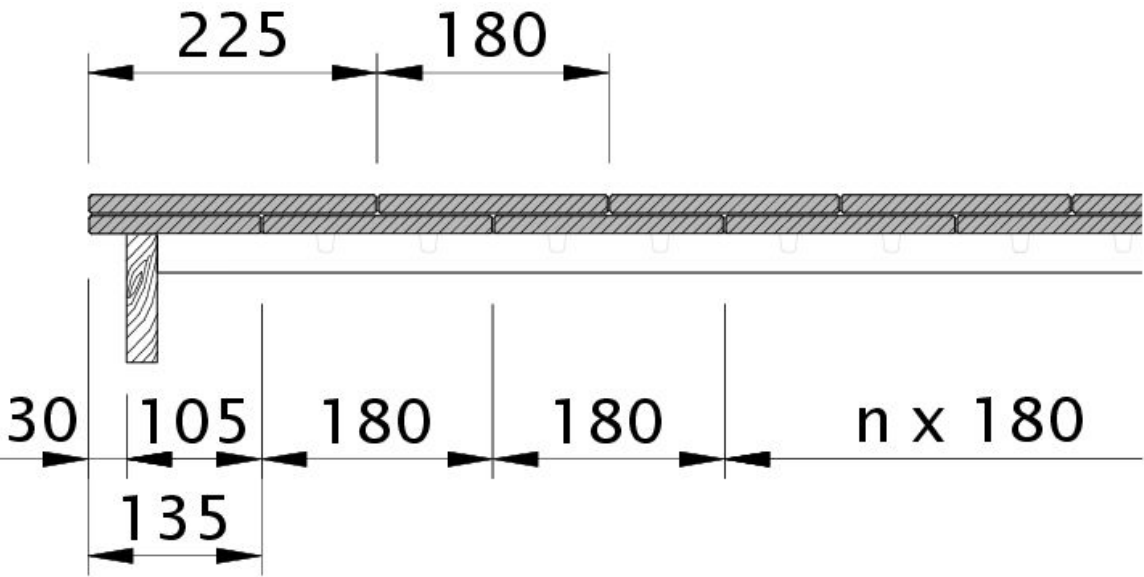

Zeichnung KLASSIK Ortgangziegel links mit Ortgangbrett und 1 1/4 Biber OBL114



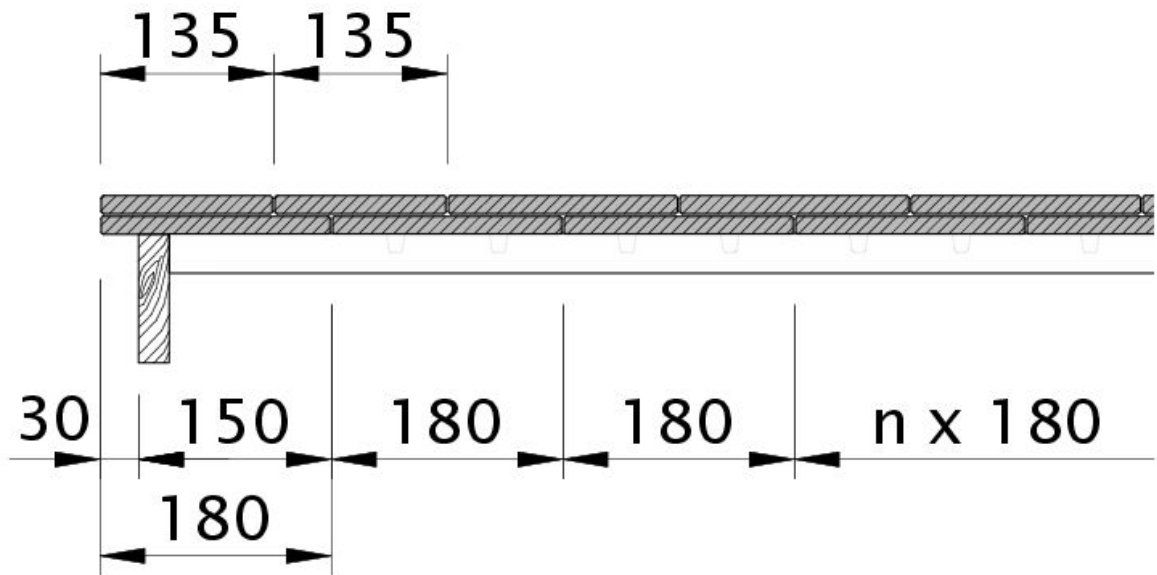

Zeichnung KLASSIK Ortgangziegel links mit Ortgangbrett und 2 3/4 Biber OBL234

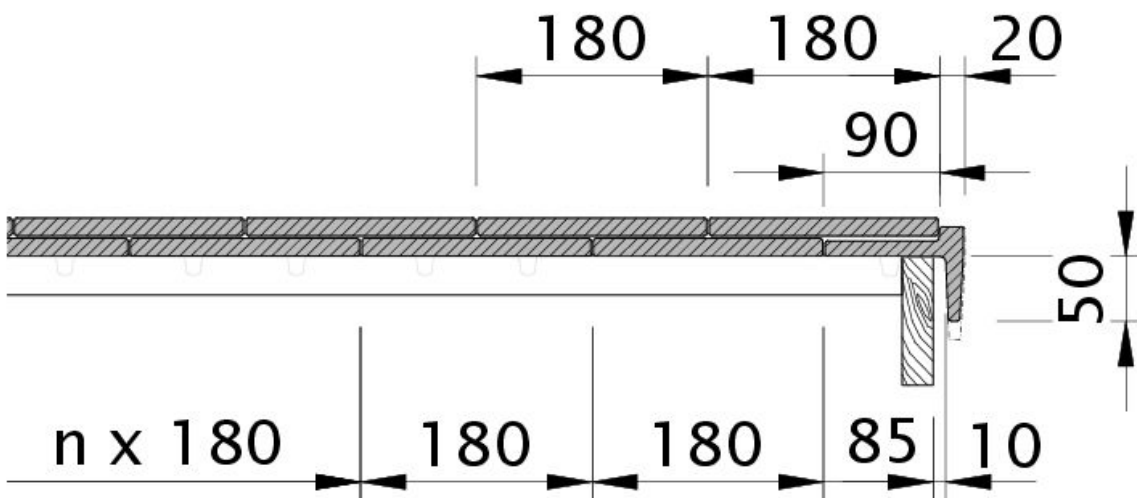

Desen tehnic produs KLASSIK Țiglă laterală dreapta OBRSCH



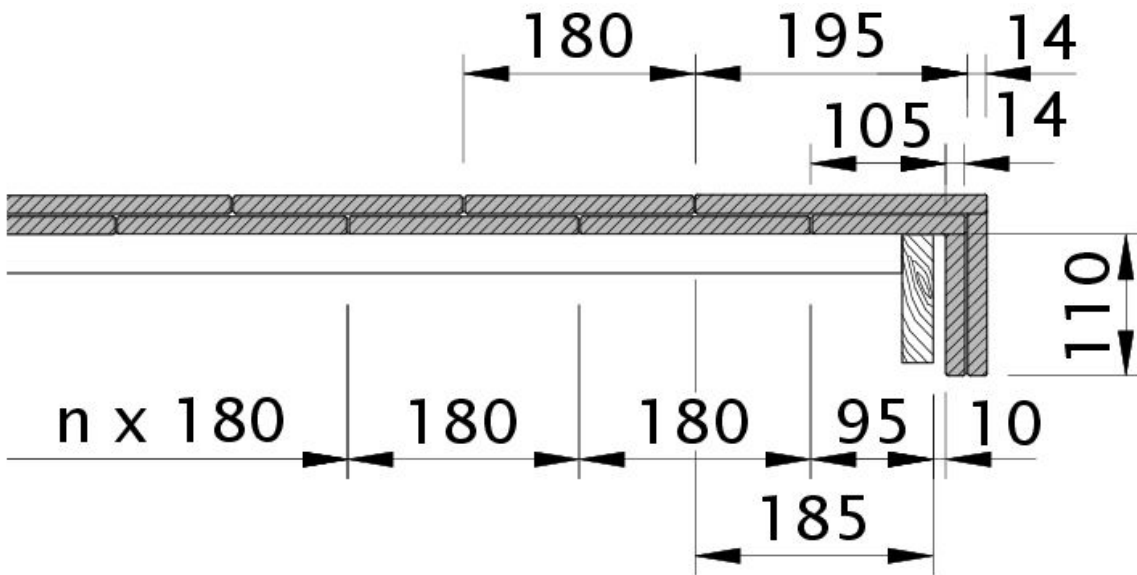

Desen tehnic produs KLASSIK Țiglă laterală dreapta OBR

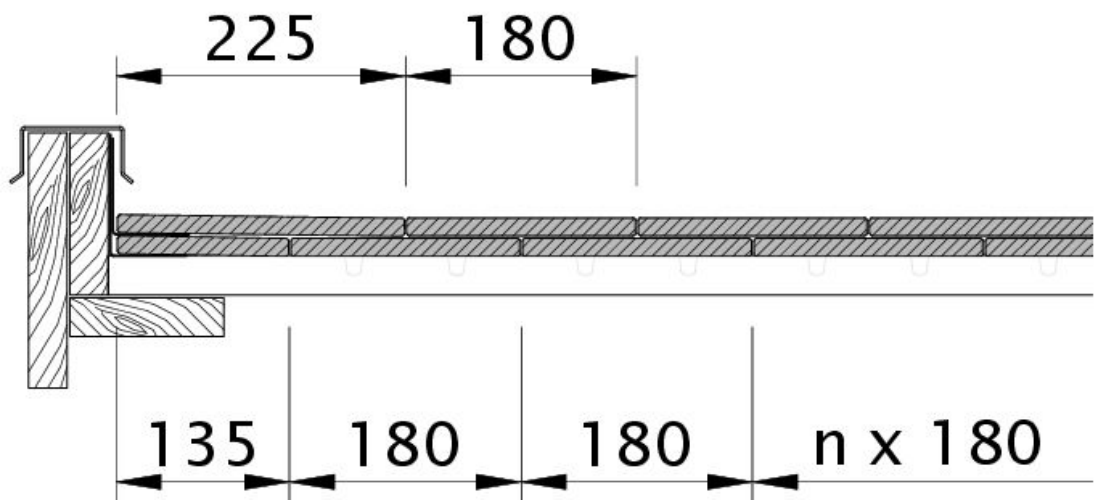

Zeichnung KLASSIK Ortgang links mit Wandanschluss OGLWA



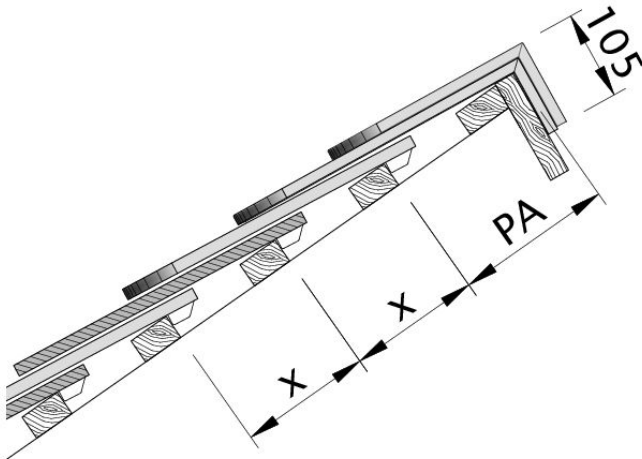

Desen tehnic produs KLASSIK PDA PDA

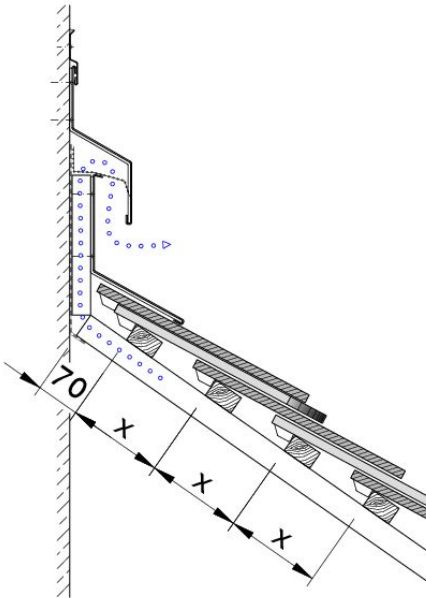

Desen tehnic produs KLASSIK WMF WMF-1



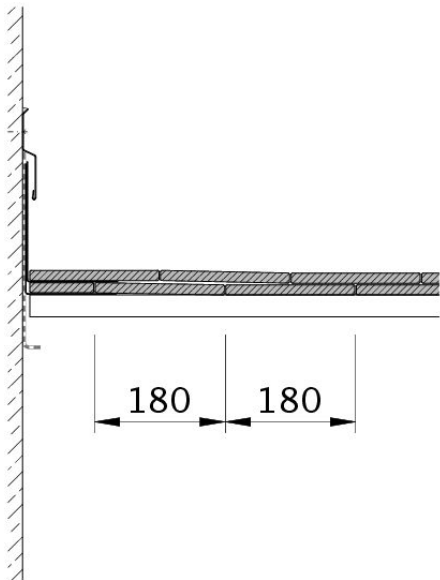

Desen tehnic produs KLASSIK WMF WMF-2

